

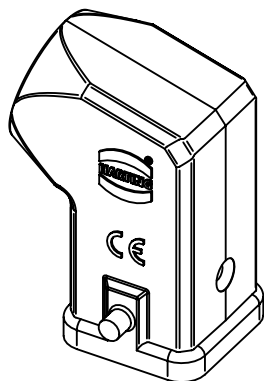

cable entry protection 09000005182
is in range of delivery

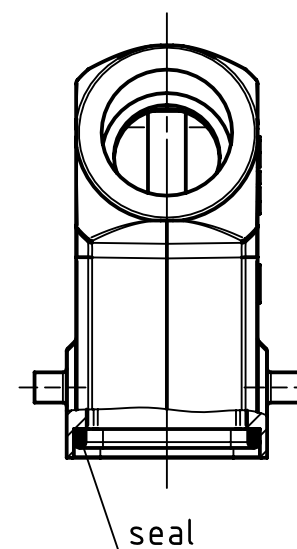
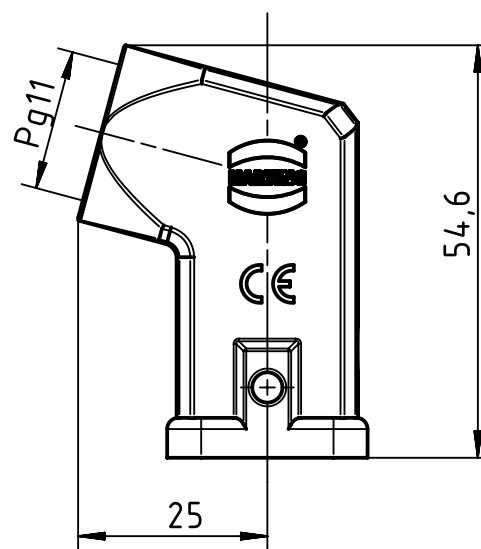
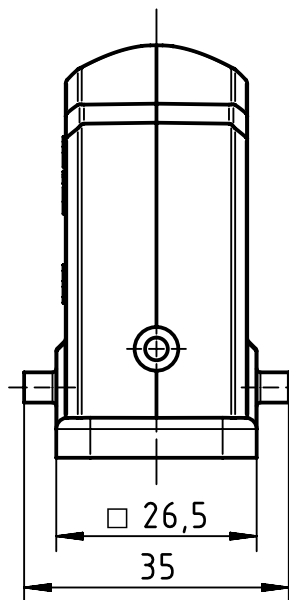
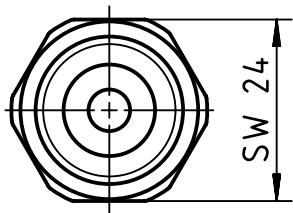
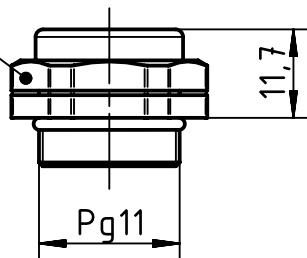

with sealing

| | | | | | |
|---|---|---|--------------------------|-------------------------------|--|
|  | All rights reserved Department EL PD | All Dimensions in mm Original Size DIN A4 | Scale 1:1 | Free size tol. ISO 2768-mK | Ref. Sub. |
| | | HARTING Electric GmbH & Co. KG D-32339 Espelkamp | Created by 402602 | Inspected by PRIESTER | Standardisation GARSKE |
| Title Han A Hood Top Angled Entry PG11 for Han | | | | | Doc-Key / ECM-Nr. 100087099/UGD/003/B 500000177612 |
| | | Type TB | Number 09 20 003 0623 | | Rev. B |
| | | | | | Page 1/1 |